

INSTRUCTIONS FOR ERECTING ROLLING OR STATIONARY TOWERS

Bil-Jax, Inc. recommends that all users of this equipment be supplied with safety information and OSHA rules and regulations. This information must be thoroughly read and understood before using the equipment. If you have not been provided with OSHA regulations or safety literature, please call 419/445-8915 before use.

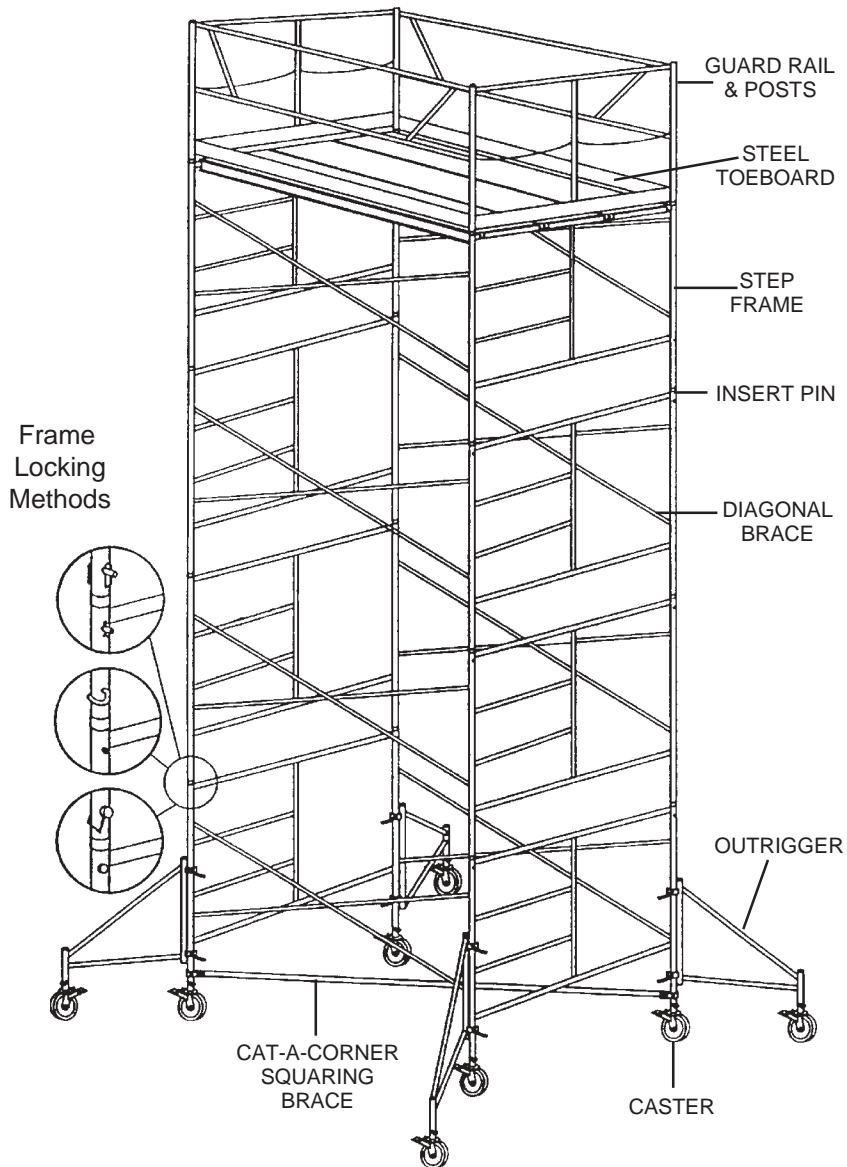

Bil-Jax Rolling Towers offer large work platform areas and adjustable platform levels, while providing workers with a quick, easy and safe assembly.

A Rolling Tower should only be used on solid, level and clear floor areas. Do not use on soil or unlevel surfaces. Check for overhead obstructions which may interfere with the tower.

NOTE: Some areas may require separate access ladders or stairs. Consult your local authorities for information before beginning scaffold erection.

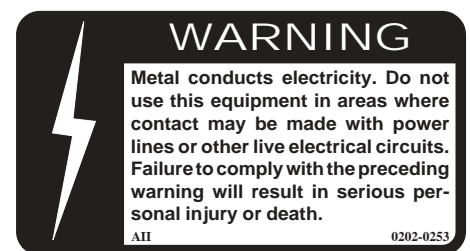

1. Before starting scaffold erection, check all parts for damage, making sure that they are in proper working order. Any part that does not look to be in good working condition or is damaged in any way should not be used.

BRACING

2. Attach diagonal bracing to frame sections, securing in place with the frame brace locks (Fig. 1).

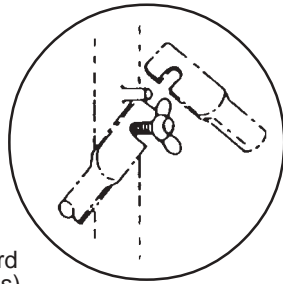

Fig. 1
J-LOCK (Standard
w/Notched Braces)

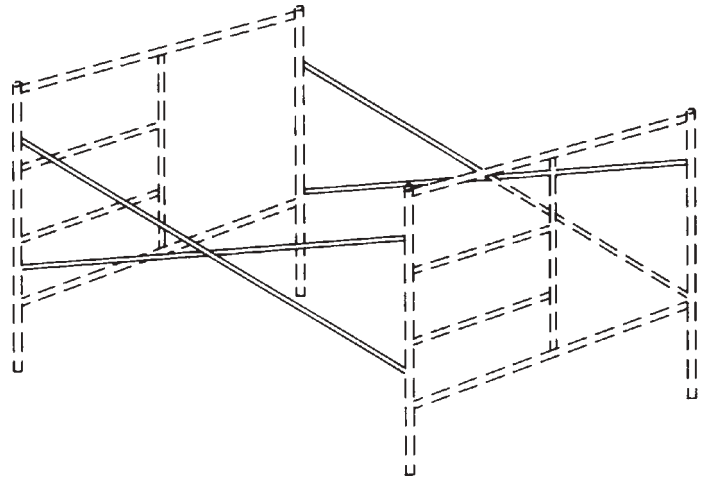

Fig. 2

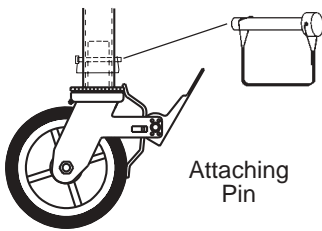
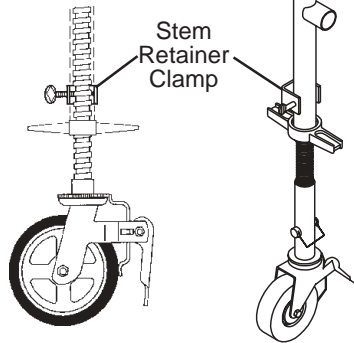

Fig. 3



CASTERS, JACKS, BASE PLATES

3. Insert casters and secure with attaching pin or bolt. Set brakes on all casters (Fig. 2) before proceeding with tower erection. If leveling casters or extensions are used, secure with stem retainer clamp, wire, or other suitable means (Fig. 3). Do not extend leveling screws more than 12". If application does not call for a Rolling Tower, follow above procedure and replace casters with leveling jacks (Fig. 4) or base plates (Fig. 5) on mud sills.

Fig. 4

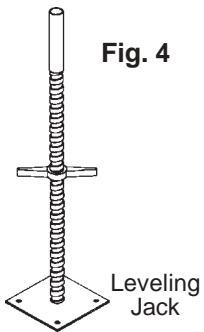
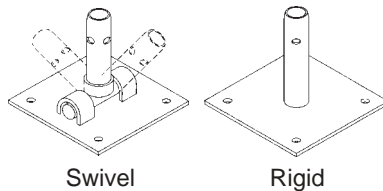
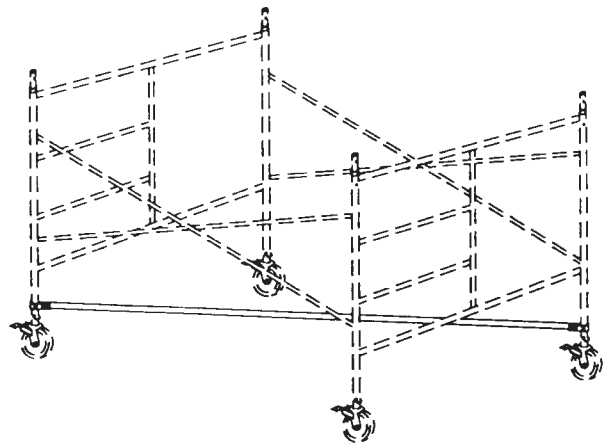
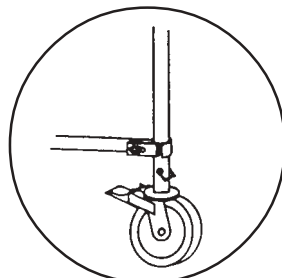

Fig. 5



CAT-A-CORNER SQUARING BRACE

4. Install cat-a-corner squaring brace (this should be installed at the base and every additional 20' of height).



OUTRIGGERS

- Determine tower height required to complete the job. If height exceeds 3 times the minimum base dimension, (see Free Standing Tower Height section below) install outriggers to increase minimum base dimension or tie in to permanent structure as codes require. Pin caster to outrigger and attach outrigger to scaffold leg. Adjust to desired angle and tighten clamp firmly to prevent movement. Set caster brakes.

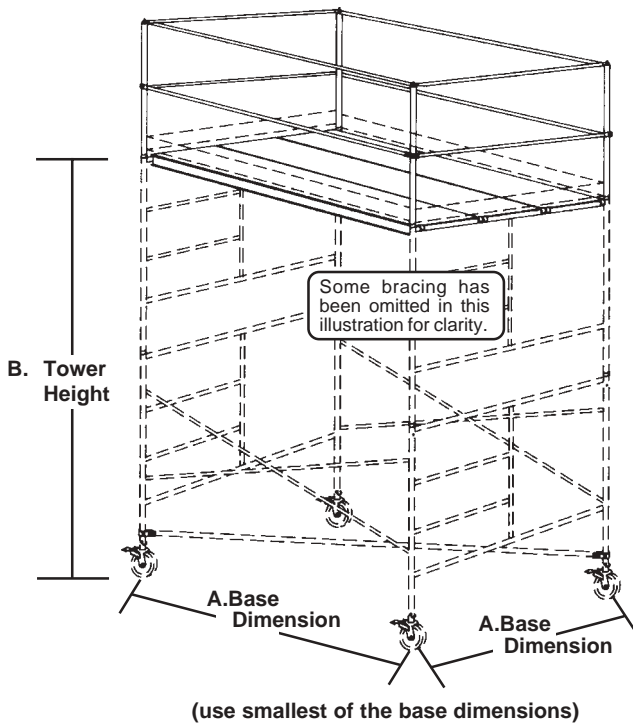
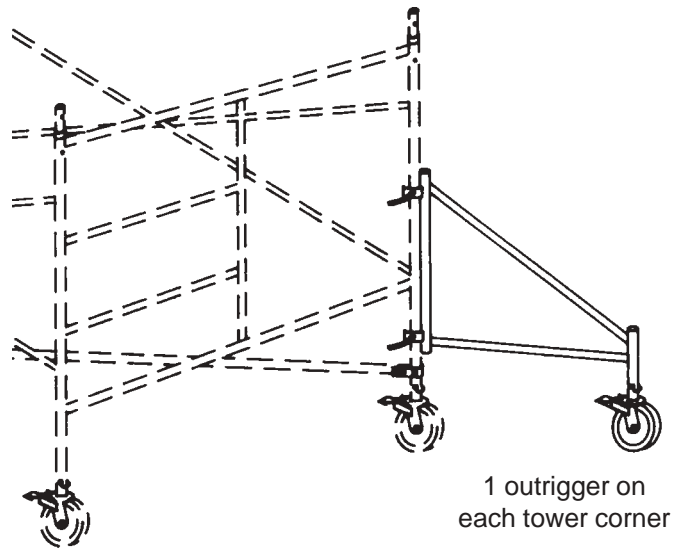

Bil-Jax, Inc. recommends the maximum free-standing tower height permitted for a Rolling Tower be 3 times the minimum base dimension, although OSHA codes allow 4 to 1 in most states. Consult your state and local codes to insure your tower complies with all applicable regulations.

$$A \times 3 = B$$

(smallest base dimension) (some states allow 3-1/2 or 4—check your local & state codes) (maximum tower height permitted)

ADDING FRAME SECTIONS

- Hoist end frames and braces to next level by means of rope and tag line. Install diagonal bracing. Secure frames together using inserts and insert locking pins. Be sure to erect step frames so that the steps continue above one another on the same side of the frame. Full decking should be installed on completed tier before attempting to assemble next tier, and should be moved up as each additional tier is completed.

NOTE: When required, access ladder or stair sections must be installed at the same time as each scaffold section is added.

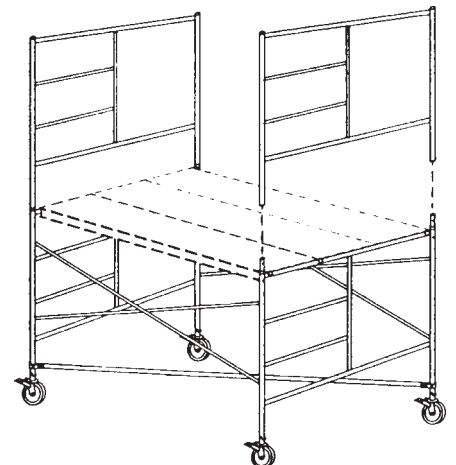

All photos and drawings are for illustration only. Always concerned with the improvement of the quality of this product, the manufacturer reserves the right to modify specifications without prior notice. Follow all applicable ANSI and OSHA Codes and Regulations for use of this equipment. Do not use this product in areas where user can come in contact with live power.

GUARD RAILING - FINAL DECKING

7. Upon completion of tower to desired height, install and lock double guard railing and toeboards on all 4 sides as required by OSHA. Make sure all guard rail posts are secured with lock pins. Install walkboards to fully deck platform work area. Secure walkboards in place by using an 8 penny nail (Fig. 6), engaging slide lock (Fig. 7), engaging rotation lock (Fig. 8), as equipped. See OSHA regulations for additional information concerning securing decking.

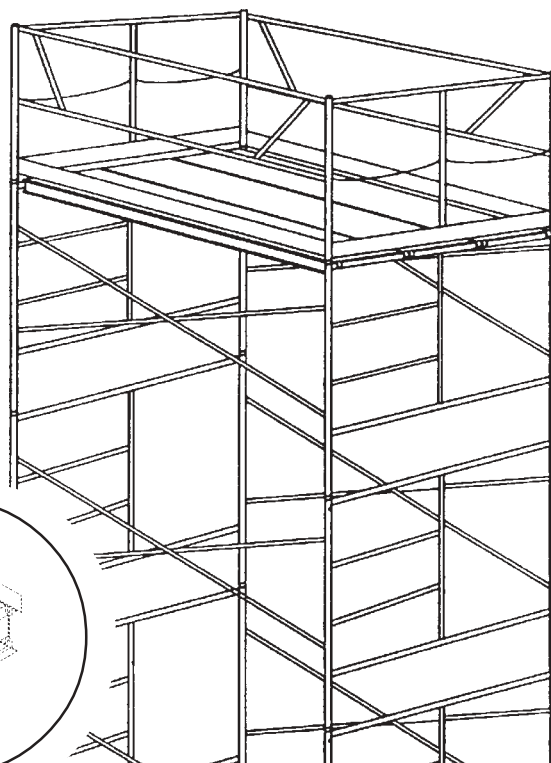
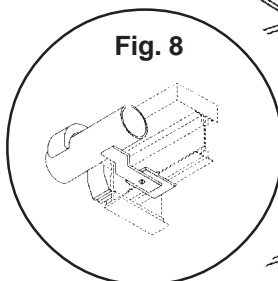
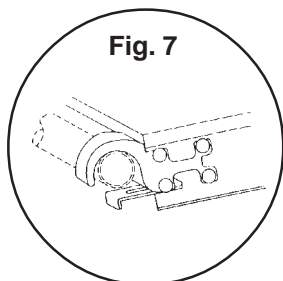
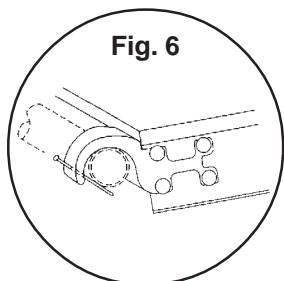

IMPORTANT: CAUTION

- Inspect scaffold daily or before each use.
- Do not exert horizontal force from on top of a free-standing scaffold.
- Do not climb or stand on cross braces or horizontal braces.
- Do not swing around corner of scaffold to enter platform from the cross brace side.
- Do not use boxes, ladders, or other means to increase working height.
- Do not stand or sit on guard rails.
- Do not use bricks, boxes, concrete blocks, or any other unstable objects under scaffold leg.
- **NEVER** ride a moving scaffold.
- Do not move scaffold by applying a pulling or pushing force at or near the top.
- Do not use braces as a platform support.
- Do not use personnel brackets (side brackets) on a Rolling Tower.
- Use approved access ladder or stairs to climb scaffold. Properly erected step type end frames will provide "equivalent, safe access" as required by OSHA.
- When hoisting material or using side brackets, scaffold must be restrained from tipping by guying, tying to a permanent structure or other acceptable means.
- Restrict loading to safe working loads. If unsure of safe load limit, consult your scaffold dealer.
- If you have not been provided with OSHA regulations or safety literature, or for any questions concerning the safe use of this equipment, call 419/445-8915 before use.

NOTE: All OSHA, state and local codes and regulations pertaining to this equipment should be obtained, read, and thoroughly understood before attempting to erect or use this equipment. Persons under the influence of drugs, alcohol, or prescription medication should not be on or near this equipment. Common sense should be implemented at all times during the erection and use of this equipment. **DO NOT USE THIS EQUIPMENT IN AREAS WHERE EQUIPMENT OR USER MAY COME IN CONTACT WITH LIVE POWER SOURCE.**

BIL-JAX[®]

125 Taylor Parkway Archbold, OH 43502-9309
Phone 419-445-8915 • 800-537-0540
Fax 419-445-0367 • www.biljax.com